

FOR MEASURABLE SUCCESS

SOEHNLE
PROFESSIONAL

BED SCALE 7711

OPERATING MANUAL

Medicine, health and wellness



www.soehnle-medical.nl

CONTENTS

1. General information	p 3	Inputs in Setting mode	p 15
Intended use	p 3	Settings in Setting mode	p 15
CE sign	p 3	Settings in "Program Settings" menu	p 15
Classification	p 3	Settings in "Terminal" menu	p 15
Safety instructions	p 4		
Use of additional devices	p 4	5. Functions	p 17
Applicator	p 4	Power-on zeroing	p 17
Operating concept	p 4	Manual zeroing	p 17
Maintenance and service	p 4	x10 (times 10) display	p 17
Cleaning	p 4	Weighing and taring	p 17
Disposal	p 4	Weighing with measured tare	p 17
Note	p 5	Weighing with manually entered tare	p 18
Warranty/liability	p 5	Weighing with stored tare values	p 18
		Provisional tare/dialysis function	p 20
2. Putting into operation	p 7	Error messages when taring	p 21
Installing the scale elements	p 7	Displaying the tare memory	p 21
Power-on	p 7	BMI function	p 21
Radio link	p 8	Hold function	p 21
Power-on / Power-off	p 8	Print	p 22
Charging the batteries	p 8	Programming the F key	p 23
		6. Error messages	p 24
3. Input and control	p 10	7. Technical information	p 26
Keypad for input and control	p 10	Technical data	p 26
Alphanumeric input	p 11	Other technical data	p 26
Indicator display	p 12	Instructions for installing the scale	p 26
Icons/characters	p 12	Electronic nameplate	
		and calibration counter	p 27
4. Setting mode	p 13	Explanation of labels and icons	p 27
Keypad in Setting mode	p 13		
Overview of menu navigation	p 14		
Calling up Setting mode	p 15		

1. General information

Thank you for choosing this Soehnle Professional product. All the features of this product were designed to the state of the art and are optimised for simple and straightforward use. If you have any queries or experience any problems with your appliance not addressed in the operating manual, please contact your Soehnle Professional service partner, or visit us on the web at www.soehnle-professional.com.

■ Intended use

The appliance is designed for weighing people who are lying down. The appliance may only be used for this purpose. Any other use is prohibited. Messages about errors or defects that could endanger the patient or operator and errors that could lead to corruption of the test results must be sent in writing to the manufacturer's medical product adviser (see address below). These operating instructions as well as the operating instructions for the 3020 Digital Indicator are component parts of the appliance. They must be kept near the appliance. Compliance with these operating instructions is mandatory in order to ensure compliance with the intended use and correct operation of the appliance. If the appliance fails to function correctly, the appliance may be damaged. It is essential that the appliance is then taken to an authorised Soehnle Professional service centre. Only genuine spare parts may be used if an authorised service station carries out repairs. These genuine parts are described in the service documentation (Spare Parts List: 470.014.037 Scale / 470.630.273 Digital Indicator / 470.014.038 Weighing Device) including Order Number.

Soehnle Professional will only assume responsibility for the safety of the appliance if these instructions are observed and the appliance is operated in compliance with the operating instructions. The appliance is a medical device and may only be used by persons who are capable of handling it correctly as a result of their training. Before using the appliance, the user must ensure that the appliance is functional and in proper working order. The operator must know how to operate the appliance. The appliance is not intended for use in medical rooms subject to explosion hazards. Explosion-hazard areas may occur if flammable anaesthetics, skin cleansing agents and skin disinfectants are used.

■ CE sign

The product carries the CE sign in accordance with the following directives:

- 89/336/EEC Electromagnetic Compatibility
- 73/23/EEC Low Voltage Directive
- 90/384/EEC Nonautomatic Weighing Instruments
- 93/42/EEC Medical Products (Class I with measurement function)



■ Classification

- Class I medical product with measuring function.
- Electrical Safety Class II (with double isolated function ground)
- No applicator
- Waterproof to IEC529:IPX2

■ Safety instructions



Before putting the appliance into use, please read with care the information given in the Operating Instructions. They contain important instructions for installation, intended use and maintenance of the appliance. **The manufacturer shall not be liable if the following instructions are not observed:**

In case the electrical components are used under increased safety requirements, compliance with the appropriate regulations is compulsory. Never perform work on the appliance while the power is switched on. Improper installation will render the warranty null and void. Ensure the voltage marked on the power supply unit matches your mains power supply. The device is designed for use within buildings. Observe the permissible ambient temperatures for use (Technical Information). The device meets the requirements for electromagnetic compatibility. Do not exceed the maximum values specified in the applicable standards. If you have any problems, contact your local Soehnle Professional service partner.

Warning: A change of the medicine device is prohibited. This device may not be changed without the manufacturer's authorisation. If the medicine device is changed, appropriate analysis and examination must be undertaken to ensure a safe continued use.

■ Use of additional devices

Only additional appliances (printer, computer) may be connected to the serial data port if they conform to European Standard EN 60601-1 or a suitable disconnecting device is connected in series.

■ Applicator

The scale does not have an applicator. No part is intended for direct contact with the patient. Leakage currents were measured on the weighing devices in compliance with classification of Type B applicators.

■ Operating concept

The appliance is operated by means of the keypad. The keys are assigned with different functions depending on the various modes.

■ Maintenance and service

The measuring inspection test was performed during the initial calibration process in production. Further regular measuring inspection tests (recalibration) must be carried out by the calibration authorities responsible in compliance with national regulations. Repairs may only be carried out by a centre authorised by Soehnle Professional using genuine spare parts. The medicine device is equipped with a non-detachable power line. The power line may not be exchanged by maintenance personal.

■ Cleaning

Before cleaning, disconnect the appliance from the mains by removing the power plug from the wall socket. Only clean the appliance using a moist cloth. On no account may water be allowed to enter into the appliance. Disinfectant may only be applied to the membrane keyboard for the display. It is prohibited to spray the appliance and the power plug.

The following disinfectants are permitted: methylated spirits, Isopropanol; 2% Kohrsolin, 1% aqueous Sokrena solution, 5% Sagrotan or 5% Gigasept.

■ Disposal



According to the present state of the art the appliance contains no special environmentally harmful substances. This product

is not to be treated as regular household waste, but should be handed in to an electrical/electronic equipment recycling centre. You can obtain further details from your local council, your municipal waste disposal company or the firm from which you purchased the product.

Battery disposal: Do not dispose of batteries in the household rubbish. As consumer you are obliged by law to return waste batteries. You can hand in your old batteries as hazardous waste to the public collection centres in your municipality or return them to the firm where you purchased them. You will find these labels on batteries containing hazardous substances: Pb = battery contains lead, Cd = battery contains cadmium, Hg = battery contains mercury. Lead-gel batteries are used to power the weighing devices. They must also be disposed of as hazardous waste and returned to the dealer when purchasing new batteries.

■ Note

Interference suppression of the unit corresponds to the valid EU Directive 89/336/EEC. The display value may be influenced by extreme electrostatic and electromagnetic interference, e.g. operation of a radio unit or a mobile phone in the immediate vicinity of the unit. When electrostatic interference is no longer present, the appliance can again be used for its intended purpose. You may need to switch it on again. The appliance is a measuring instrument. Air currents, vibrations, rapid changes in temperature and direct

sunlight may have an effect on the accuracy of the scale. The scale is protected to IP 54 protection class. Therefore, avoid high levels of humidity, vapours, aggressive liquid media and strong contamination.

■ Warranty/liability

If the appliance is delivered with a fault or defect which is within Soehnle Professional's scope of responsibility, Soehnle Professional is entitled to either repair the fault or supply a replacement appliance. Replaced parts remain the property of Soehnle Professional. Should the fault repairs or replacement delivery not be successful, the statutory provisions shall apply. The period of warranty shall be 2 years, beginning on the day of purchase. Please retain your receipt as a proof of purchase. If your scale requires servicing, please contact your dealer or Soehnle Professional Customer Service. Only genuine spare parts may be used if an authorised service station carries out repairs. Soehnle will only assume responsibility for the safety of the appliance if these instructions are observed and the appliance is operated in compliance with the operating instructions.

No responsibility shall be accepted for damage caused by any of the following reasons: unsuitable or improper storage or use, incorrect installation or putting into operation by the owner or third parties, natural wear and tear, changes or modifications, incorrect or negligent handling, excessive use, chemical, electrochemical or electrical interference or humidity, unless this is attributable to negligence on the part of Soehnle Professional. If operating, climatic or any other influences lead to a major change in conditions or material quality, the warranty for perfect

ENGLISH

BED SCALE 7711

unit functioning shall be rendered null and void. If Soehnle Professional provides an individual warranty, this means that the appliance supplied will be free from faults for the duration of the warranty period. Always keep the original packaging in case you have to return the scale.

2. PUTTING INTO OPERATION

■ Installing the scale elements

The indicator's placement must allow for a simple disconnection from the power supply. Insert rechargeable batteries in all four weighing devices. When the batteries are fitted, the weighing devices start to send and attempt to set up a radio link to the digital indicator.



Caution (Fig 1-4 right):

Before switching on the scale, place the weighing devices under the four wheels of the hospital bed. Push the weighing devices as far as the stop under the wheels. Press the lever down and raise the bed wheel. (The weighing devices are designed to receive wheel diameters of 130–160 mm. Small diameters are optional.)

■ Power-on / Power-off

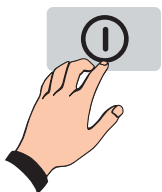

Switch on or off the digital indicator by pressing the On/off switch.

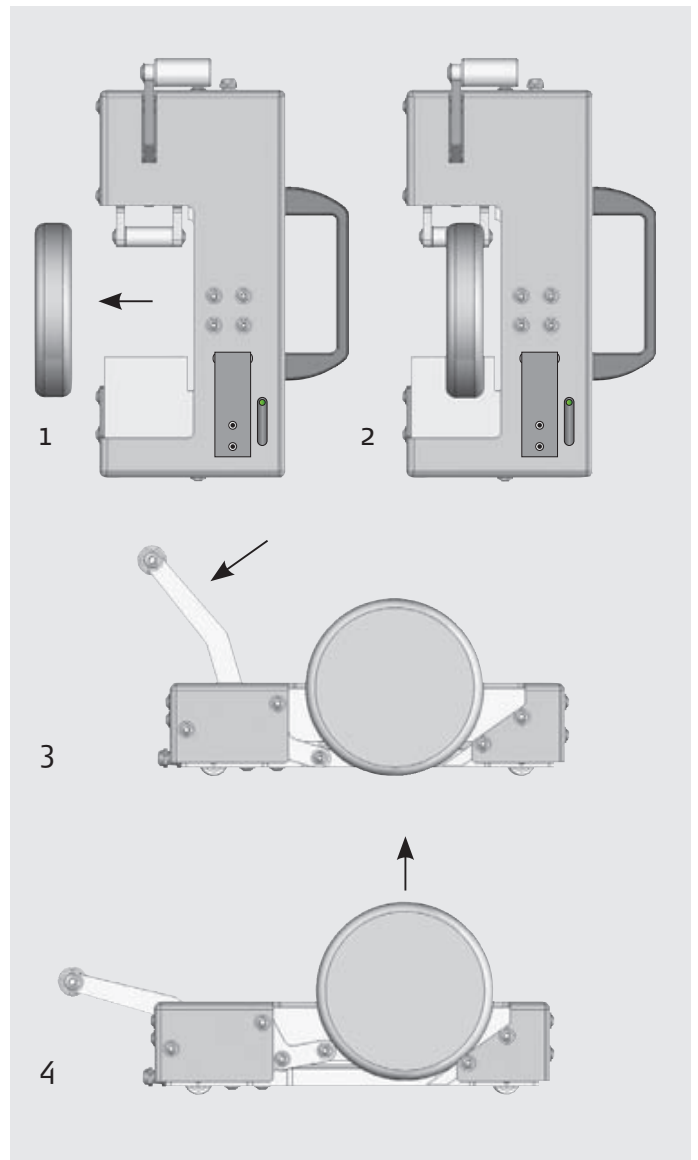

The message "SOEHNLE PROFESSIONAL" appears in the indicator display together with a search icon until the radio link is set up to the weighing devices. This normally takes 20 to 60 seconds.

When the radio link to the weighing devices is set up, the indicator display shows the current gross weight value.

■ Radio link

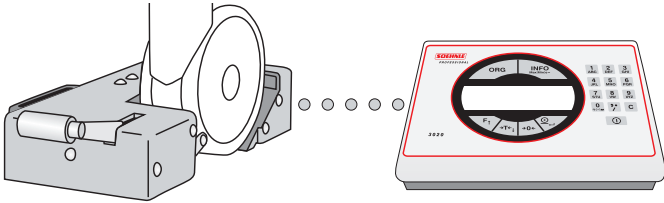

The Bluetooth radio link operates over a max. radius of 5m if there is no partition wall between the weighing devices and the digital indicator. After short interruptions (e.g. to replace a battery or caused by the loss of battery contact due to shocks), the link is restored automatically within a few seconds.

■ Power-off

If the sensors are overloaded or you have started a menu, the scale switches off after you press the On/Off button for 5 seconds. It is not possible to switch off the scale as long as it is waiting for an input in the editing section of Setting mode.

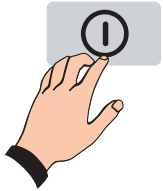

First exit the editing section before switching the scale off.

The weighing devices have no on/off switch. They are only switched off when the batteries are removed.

OFF display

When the scale is switched off but remains connected to the power supply, the indicator display shows "OFF" (in accordance with the Medical Equipment Directive).

■ Charging the batteries



Open the cover of the battery charger. The charger has four compartments to recharge the four batteries simultaneously. The four LEDs

indicate the charge state for each battery. The fifth LED on the charger is the mains power indicator for the charger itself.

LED status indicator on charger (for each charge compartment):

- LED lights up orange: battery still charging
- LED lights up green: battery charged – trickle charge

LED status indicator on weighing device:

Digital indicator is switched on (radio link active)

- LED lights up green: battery charged
- LED flashes green, mainly on, off for short periods: battery still has sufficient capacity for normal operation
- LED flashes green, normally off, only on for short period : battery almost empty, battery must be recharged

Digital indicator is off or in standby mode

- LED lights up green for approx. 2 mins and then starts to indicate standby mode by flashing (mainly off)

The charging time for empty batteries is approx. 4 hours. Batteries should be charged and exchanged in sets. The batteries may remain for any length of time in the charger when it is on.

Display of link state:

Press Info key + 1. The following appears in the indicator display:

Weighing device	State	Battery voltage
1: 0080025005BB7	OK	6.3 V
2: 0080025005CoD	Error	
3: 0080025005C70	OK	6.3 V
4: 0080025005ADC	OK	6.3 V

Charge run time:

A battery charge is sufficient for approx. 12 hrs continuous duty. When the scale is switched off for most of the time (90% OFF), the batteries may remain in the weighing devices for up to 125 hours before they require a recharge.

Caution: Even when the digital indicator is switched off, the Bluetooth link is activated at regular intervals. For this reason, the batteries will discharge in this state and must be recharged at the latest after 125 hours.

Recommendation:

Always remove the batteries from the weighing devices after you switch off the digital indicator and place them in the battery box of in the charger. This makes sure that the scale works reliably the next time it is switched on.

If the bed scale remains for long period of time without use, remove the batteries from the weighing devices to prevent deep discharge. The scope of supply comprises eight batteries.

3. INPUT AND CONTROL

■ Keypad for input and control

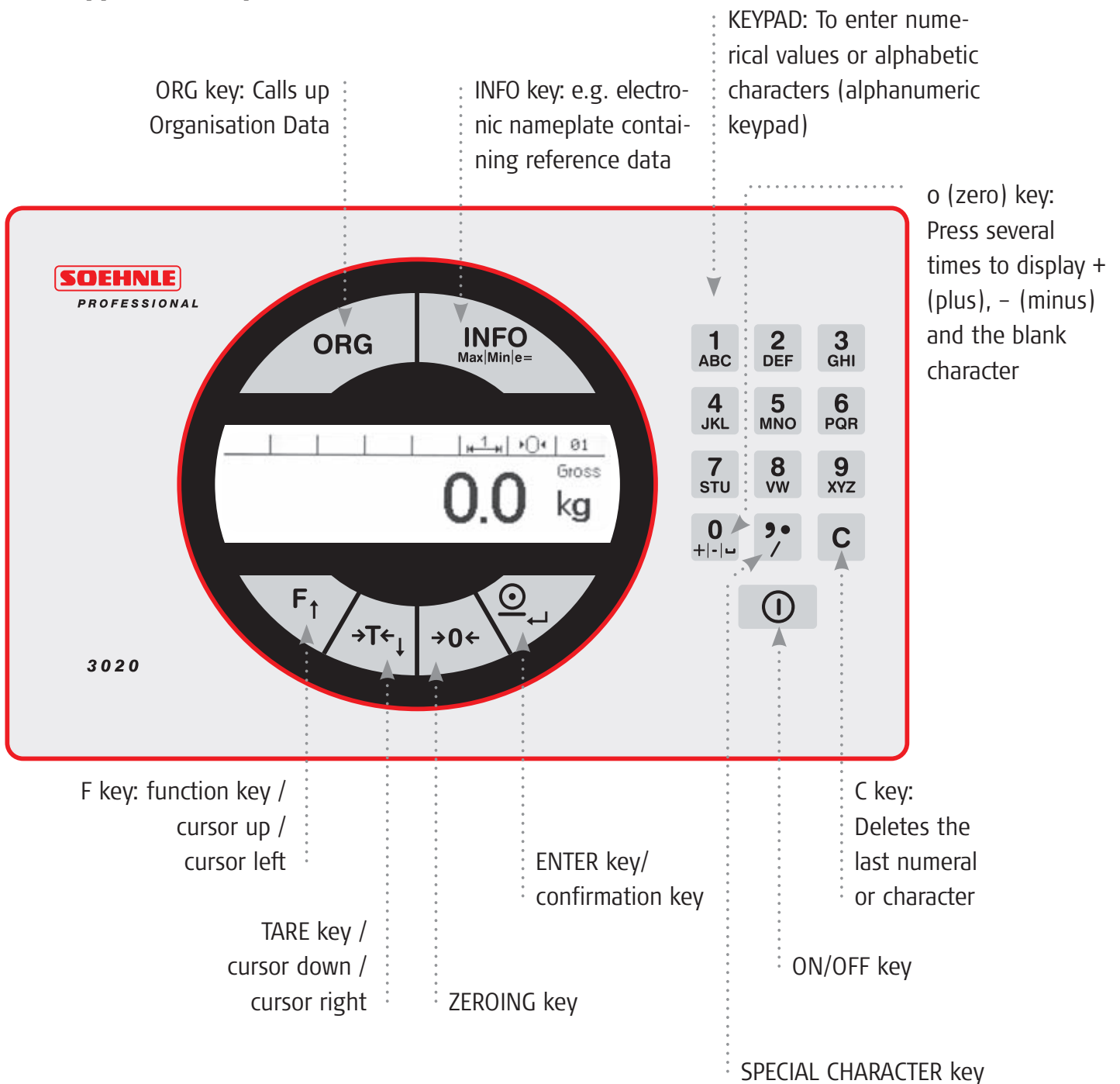

■ Alphanumeric input

It is possible to make alphanumeric inputs with the combined numeric and alphabetic character keypad.

Types of input box

- Display fields, read only
- Display/writing fields with numeric input option
- Display/writing fields with alphanumeric input option

Input procedure

Numeric fields: Type in the numerals 0 to 9 directly into the KEYPAD. Input is right-flush. A cursor flashes under the last digit entered. The C key clears the numeral highlighted by the cursor. The ZEROING key aborts the input without saving the new input values. Existing values are retained. The Enter key saves the value typed in and returns to the application program. The setpoint, whether it is a dot, comma or no decimal separator, is defined in Setting mode (Setting mode > Terminal > Display > Decimal separator, see p 14). Only the default number of characters can be typed into an input box. Any other inputs are neither displayed nor accepted.

Alphanumeric fields: The numeric keys are also assigned by multiple programming to alphanumeric characters (upper case only) and characters. For example, the 0 (zero) key is also a +, - and blank character. The SPECIAL CHARACTER key is also available.

After pressing a numeric key twice within one second, this activates a rolling function to access a character assigned to this key. If you do not press the key a second time within one second, the cha-

acter pressed is accepted and the cursor moves on to the next position.

Numerical inputs can be made in direct succession without any waiting period, as long as the same number key is not pressed several times in succession. A cursor flashes under the last item entered. Press the F key and the TARE key to move the cursor to the left or right. The C key clears the last character on the left of the cursor or the character with the cursor flashing underneath it.

The ZEROING key aborts the input without saving the new input values. Existing values are retained. The ENTER key saves the value typed in and returns to the application program. Only the default number of characters can be typed into an input box. Any further input overwrites the last character.

■ Indicator display

The display shows a number of different views depending on the situation. It is divided into display panes.

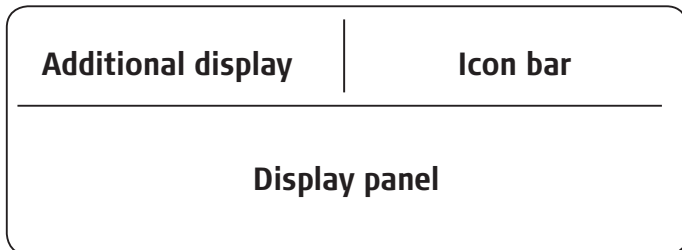

Additional display

It displays BMI, Gross, Net, etc. If required, it can be switched on with the F key according to the program settings.

Icon bar

Shows information about the status of the active measuring point.

Display panel

Shows weight value and unit characters.

■ Icons/characters

Icons in the icon bar

 Alibi memory capacity 100%

 Alibi memory capacity 80%

 Alibi memory capacity empty

 Keylock

 Multirange/Multidivision 1

 Multirange/Multidivision 2

 Multirange/Multidivision 3

 Resolution x10 (10 times)

 Zero

 Hold function active

 Unit character

Symbol for standstill

After placing a load on the scale (bed, patient, etc.), the scale requires time to finish oscillating. Until it comes to a standstill the unit character (kg, lb) remains blank. The unit character only appears when the scale reaches standstill and a stable value is obtained (clip off).

4. SETTING MODE

■ Keypad in Setting mode

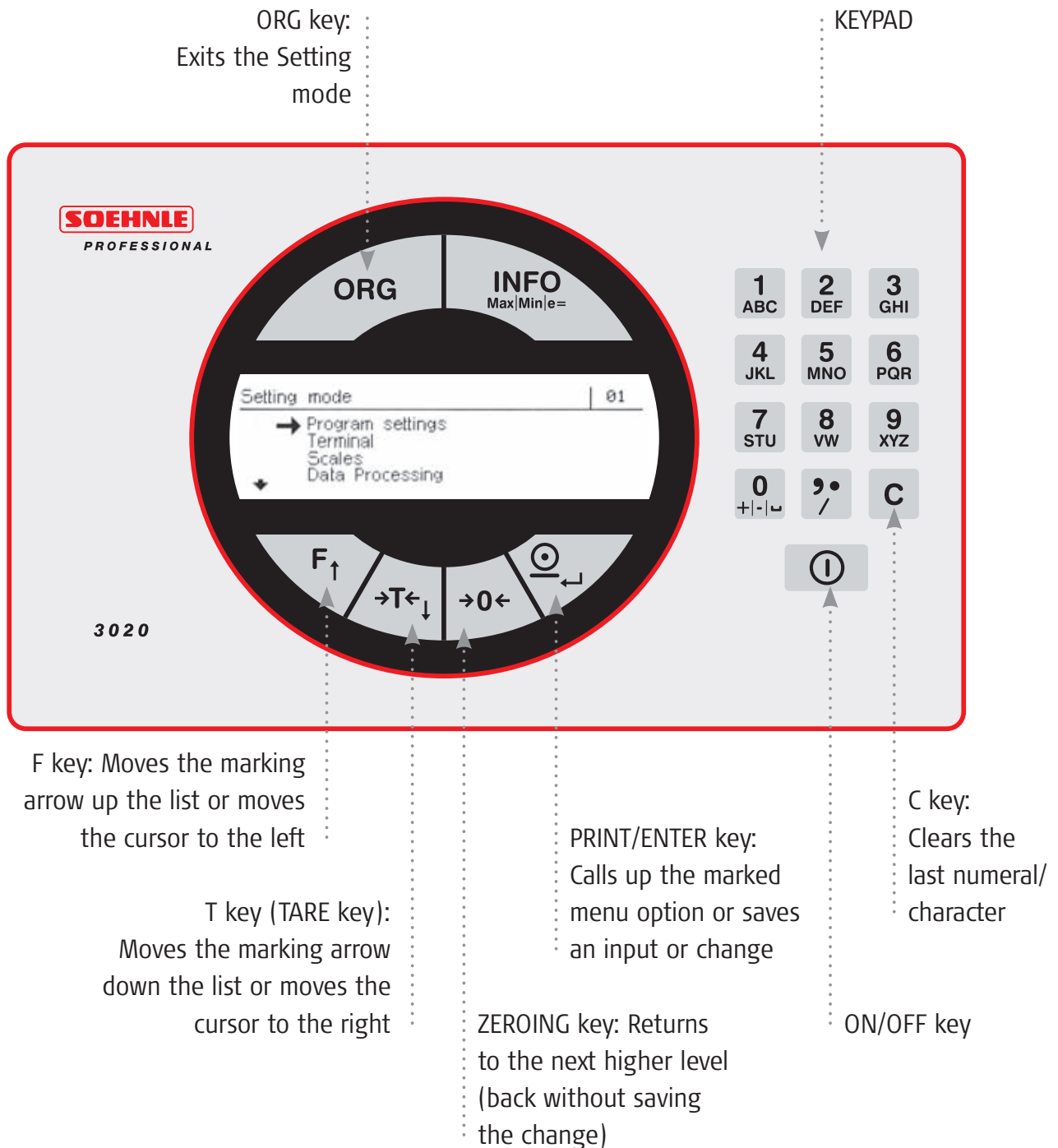

■ Overview of menu navigation

The following setting options are available:

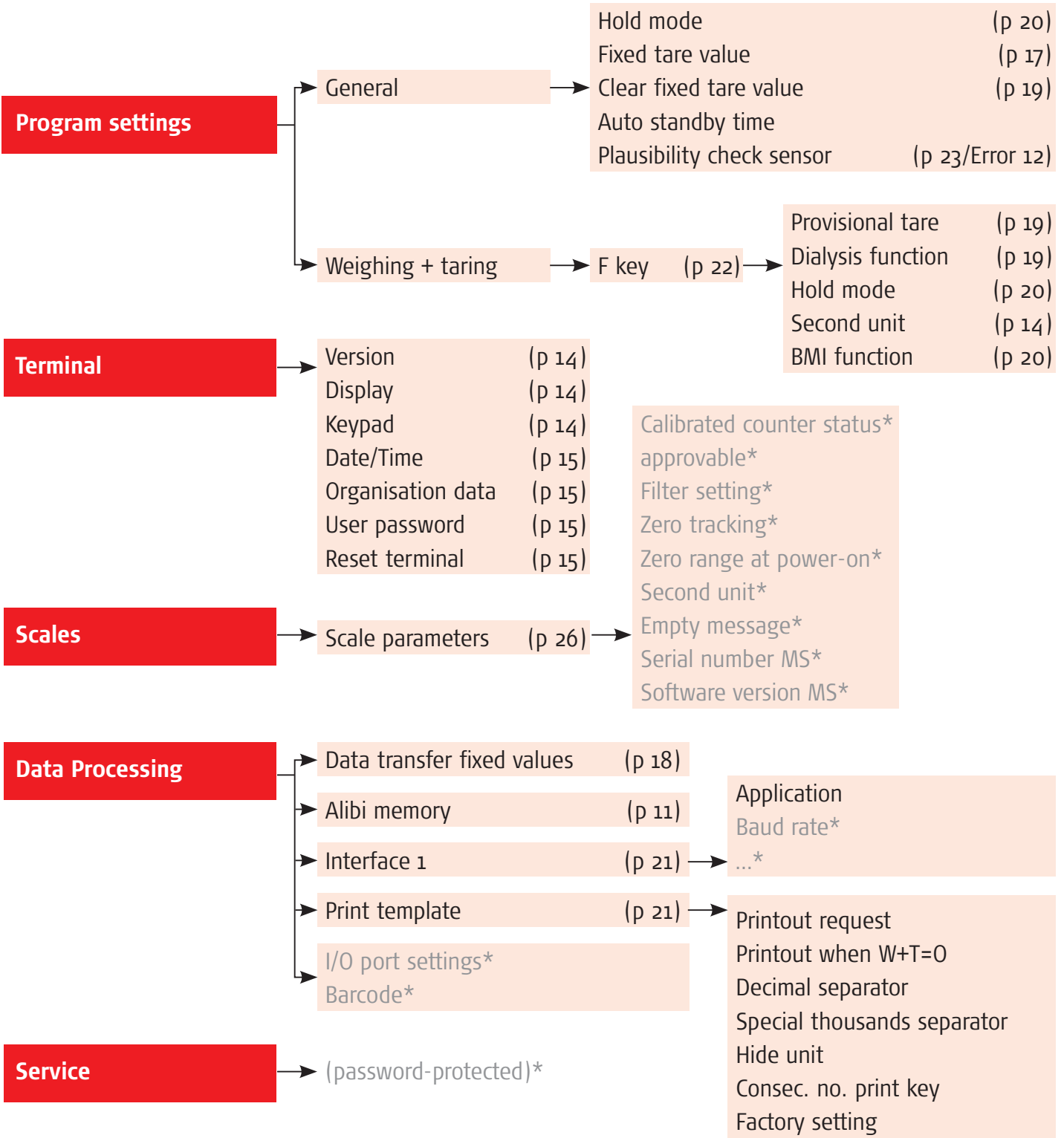

* Only for service personnel authorised by Soehnle Professional

■ Calling up Setting mode

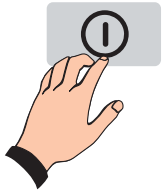

Switch the appliance on. After the power-on routine, the appliance starts the last activated application program automatically. To call up Setting mode first

press ENTER and then the F key simultaneously. You are now in the Setting mode selection menu.

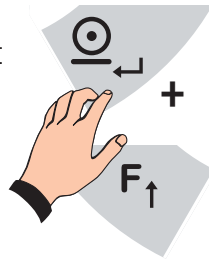

■ Inputs in Setting mode

In most cases you can select from several different settings available. With editable values, you can type in values into the numerical or alphanumeric keypad.

■ Settings in Setting mode

With the parameters in Setting mode, you can adapt the weighing and taring application program to your specific requirements.

■ Settings in "Program Settings" menu

In the "Program Settings" Settings menu, you can adapt the Application program of your scale to your specific requirements – the bed scale mainly uses "Weighing and taring".

■ Settings in "Terminal" menu

In "Terminal" Setting mode, you will find the following request and setting options.

Version

AZG software version	Display only
AZG applications software	Display only
AZG serial number	Display only
CPU board serial number	Display only

Display

Backlight	Sets the luminosity, enter as a percentage into the numerical keypad; 0% = dark, 100% = fully luminosity; factory setting: 80%
Contrast	Contrast setting, enter as a percentage into the numerical keypad; 1% is lowest contrast, 100% is full contrast; factory setting 50%
Language	Deutsch/English/François
Decimal separator	Comma, point or none Factory setting: comma
Second unit	g/t/lb/mg/oz (additional field in display)

Keypad

Keylock	Individual, several or all keys on the keypad can be locked. Press the key to be locked to change the status of the key from "unlocked" to "locked" and vice versa.
---------	---

ENGLISH

BED SCALE 7711

	To accept, press ENTER for 3 seconds.
Keytone	Select "off" or "on". Confirmation tone when a key is pressed. Factory setting: "off"
Validation tone	Select "off" or "on" Validation tone when a function is executed. factory setting: "off"

Date/time

Time	Enter into numerical keypad. Press ENTER to start clock after confirmation
Date	Enter into KEYPAD
Date format	Select European or imperial date; factory setting: European

Organisation data

Description of ORG A	Enter the description of the organisation data memory A; numerals or text entered into KEYPAD, e.g. "Bed number", "Room number" max. 12 characters
Description of ORG B/ ORG C/ ORG D	Further input options for other organisation data memories, see above

User password

New/change	Enter password with up to 8 characters into keypad; after activation, the Setting
------------	---

	mode is only accessible by password. If you forget your password, type in the word CLEAR to release access.
Clear	Clears the password and releases access

Reset terminal

Do not execute/ Executes	"Execute" clears all the individual terminal settings and resets to factory settings
-----------------------------	--

5. FUNCTIONS

■ Power-on zeroing

During the power-on procedure, the weight values sent by the weighing devices are zeroed until they are less than 50% of the max. weighing range. This tares the empty bed and the weight display goes to zero.

■ Manual zeroing

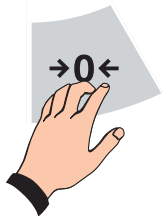

Manual zeroing corrects minor deviations from zero, e.g. caused by soiling on the scale. The following character appears in the icon bar when the display indicates zero: >0<.

Zero range approvable and non-approved: 1% to +3% of the weighing range.

If zeroing is not possible, the error message "Value above zero range limit" or "Value below zero range limit" appears for two seconds in the display.

■ x10 (times 10) display

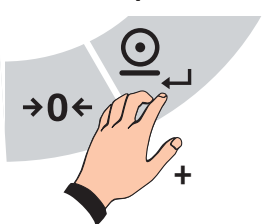

Shows the weight value with an additional decimal place at ten times the resolution. Switch to the x10 display by pressing ENTER and then the ZEROING

key simultaneously. According to the calibration law, the x10 function may only be activated on approvable scales for a short period of time. For this reason, it is programmed so that the function is switched off automatically after 5 seconds. The message x10 appears in the icon bar as long as the 10-time higher display is selected. When the appliance is switched off, the function is deactivated.

■ Weighing and taring

Display view



■ Weighing with measured tare

Determine and tare a bed weight without patient.

Position the empty bed, including bedding, on the scale. Press the TARE key. The tare value is saved and the weight display goes to zero. Now the patient can be laid on the bed. The weight is displayed with the message "Net".

Displaying the value in the tare memory

Press the INFO key to display the tare memory and then the TARE key. Press the ZEROING key to terminate the display.

Changing the tare value manually later

Display the tare value by pressing the INFO key and then the TARE key. Enter the new value into the KEYPAD. The ZEROING key cancels the input. Existing values are retained or new tare values are saved by pressing the TARE key. Confirm by pressing ENTER and return to the application program.

■ Weighing with manually entered tare

If the patient is already on the bed and the bed weight is known, then this can be tared by manual input.

Enter the known bed weight (tare weight) using the KEYPAD. The input appears in the display with the current weight unit. Press the TARE key. The input is transferred into the tare memory and the tare weight is deducted from the weight display. The patient's weight measured in this way is displayed with the message "Net".

Showing the value in the tare memory

Display the tare memory by pressing the INFO key, then press the Tare key. Press the ZEROING key to end the display.

Changing the tare value manually later

Show the tare value by pressing the INFO key and then the TARE key. Enter the new value into the KEYPAD. Press the ZEROING key to cancel the input. The existing value is retained or the new tare value is saved by pressing the TARE key. Confirm by pressing ENTER and return to the application program.

■ Weighing with stored tare values

Known bed weights can be stored as the tare value in a power failsafe memory and called up as required (100 different bed weights are possible).

Each memory location has a:

- Three-digit consecutive number
- Description (text, 18 characters)
- Tare value

Entering tare weights into the fixed tare value memory

- Call up the input menu (Setting mode > Program Settings > General > Fixed tare values)
- Press ENTER and F key simultaneously to access Setting mode.
- The arrow points to "Program Settings". Confirm by pressing ENTER.
- Confirm the message "General" by pressing ENTER.
- Press TARE to browse to "Fixed tare values" and accept by pressing ENTER.

Entering values

- If no tare memory has yet been assigned, the first free, or otherwise the last, selected fixed tare value memory is displayed.
- Press ORG followed by ENTER. The input field for the description of a new tare memory is displayed.
- Enter the description into the KEYPAD and confirm by pressing ENTER.
- The arrow points to "Tare value". Press ENTER. The input field is displayed to enter the tare value.
- Enter the tare value and confirm by pressing ENTER.
- Go back by pressing the ZEROING key to select the tare memory.
- If you want to assign other tare memories, press the ORG key to select the next free memory location and repeat the procedure as described above.
- To return to weighing mode, press the ZEROING key and then the ORG key.

Transferring fixed tare values from a PC to the digital indicator

- Here you require a special software. For more information, please contact the Soehnle Professional Service personnel.

Changing or overwriting a fixed tare value memory

- **Call up the Input menu (Setting mode > Program Settings > General > Fixed tare values)**
- Press ENTER and the F key simultaneously to access Setting mode.
- The arrow points to "Program Settings". Confirm by pressing ENTER.
- Confirm the message "General" by pressing ENTER.
- Press the TARE key to browse to "Fixed tare values" and accept by pressing ENTER.

Correcting values

- The last selected fixed tare value memory is displayed. Press the F or TARE key to select the tare memory to be changed or enter the memory location number and confirm by pressing ENTER.
- Press ENTER. The input field for the tare location description is displayed.
- Change the description by typing it into the KEYPAD and confirm by pressing ENTER.
- The arrow points to "Tare value".
- Press ENTER. The input field for the tare value is displayed.
- Change the tare value by typing it into the KEYPAD and confirm by pressing ENTER.
- Go back to the tare memory selection by pressing the ZEROING key.

- If you want to change other tare memories, press the F key of the TARE key to select the next memory location to be changed and repeat the procedure as described above.
- To return to weighing mode, press the ZEROING key and then the ORG key.

Calling up the list of fixed tare value memories for taring

The tare value from the fixed tare value memory can be activated with the scale unloaded (i.e. before the weighing operation) or with the scale loaded (during a weighing operation).

- The display pane shows a weight value ≥ 0.000 kg.
- First press ENTER and then the TARE key simultaneously. The fixed tare value memory last used appears in the display.
- Press the F or TARE key to browse to the required fixed tare value memory or type in the memory location number and confirm by pressing ENTER.
- Press ENTER to activate the fixed tare value. The display shows the gross value minus the tare value (net).
- Further tare values from the memory are activated by repeating the procedure described above.

Clearing an existing fixed value

- **Call up the input menu (Setting mode > Program Settings > General > Fixed tare values)**
- Press ENTER and the F key simultaneously to access Setting mode.
- The arrow points to "Program Settings". Press ENTER to confirm.

- Confirm the message "General" by pressing ENTER.
- Press the TARE key to browse to "Fixed tare values" and accept by pressing ENTER.

Clearing a tare value

- The last selected fixed tare value memory is displayed. Press the F or TARE key to browse the required fixed tare value memory or enter the memory location number and confirm by pressing ENTER.
- Clear the displayed fixed tare value memory by pressing the C key.
- The gap in the consecutive number scheme is closed. The following fixed tare value memories are given a number reduced by 1.

CAUTION: Under Setting mode > Program Settings > General > Delete fixed tare values, all fixed values are cleared from the memory!

■ Provisional tare/dialysis function

Setting and using the operating mode

- **Setting in Setting mode**
(Setting mode > Program Settings > Weighing + Taring > F key > Dialysis function)
- Press ENTER and the F key simultaneously to access Setting mode.
- The arrow points to "Program Settings". Press ENTER to confirm.
- Press TARE to browse down to "Weighing + Taring" and press ENTER to confirm.
- Confirm the message "F key" by pressing ENTER.
- Press TARE (down) or the F key (up) to browse to "Dialysis function" and press ENTER to confirm. There is an acoustic acknowledgement.

- Exit Setting mode by pressing the ORG key. The gross value is displayed.

Using the dialysis function

- Press the F key (with a load on the scale). Message: "Place tare". Place the additional tare on the scale. Confirm by pressing TARE. The additional tare is accepted into the tare memory and the net value remains unchanged.
- Repeat this procedure for other additional tares. The weight is displayed with the message "Net". When the scale is clipped off, the tare weight is displayed with a negative sign.
- Clear the tare by pressing the ZEROING key.

Displaying the value in the tare memory

To display the tare memory, press the INFO key and then the TARE key. Press the ZEROING key to exit the display.

Changing the tare value manually later

Display the tare value by pressing the INFO key and then the TARE key. Enter the new value into the KEYPAD. Press the ZEROING key to abort the input. The existing value is retained or the new tare value is saved by pressing the TARE key. Confirm by pressing ENTER and return to the application program.

■ Error message when taring

"Error o6 Taring not possible"

Possible causes:

- Scale empty
- Scale in overload or underload
- Manual tare input with tare value above maximum load

■ Displaying the tare memory

To display the tare memory, press the INFO key and then the TARE key. Press the ZEROING key to end the display.

■ BMI function

The Body Mass Index (BMI) is used to assess whether a person has a normal weight or is overweight. The BMI is calculated according to the following formula:

$$\text{BMI} = \frac{\text{body weight (kg)}}{\text{body height (m)} \times \text{body height (m)}}$$

The unit for the BMI is therefore kg/m².

BMI classification separated according to gender:

Classification	m	w
Underweight	< 20	< 19
Normal weight	20-25	19-24
Overweight	25-30	24-30
Adiposity	30-40	30-40
Severe adiposity	>40	>40

Setting and using the operating mode

- **Setting in Setting mode (Setting mode > Program Settings > Weighing + Taring > F key > BMI function)**
- Press ENTER and the F key simultaneously to access Setting mode.
- The arrow points to "Program Settings". Press ENTER to confirm.
- Press the TARE key to browse down to "Weighing + Taring" and press ENTER to confirm.
- Confirm the message "F key" by pressing ENTER.
- The arrow points to the last function activated.
- Press the TARE key to browse to "BMI function" and press ENTER to accept. A beep tone confirms acceptance.
- Exit Setting mode by pressing the ORG key. The weight value is displayed.

Using the BMI function

- Press the F key. The following message appears: "Enter body height". Enter your body height in metres.
- Confirm by pressing ENTER. Now, parallel to the person's weight, the BMI value is displayed in the additional display.
- The BMI display can be switched off by pressing the F key again.

■ Hold function

- **Setting in Setting mode (Setting mode > Program Settings > General > Hold mode)**

The Hold function "Hold mode" freezes the measured value in the display dependent on the selected setting. The following settings are possible:

not active: Hold mode is off.

Still/Key: Value freezes.

Press the ON/OFF to cancel Hold mode.

Still/Empty: Value freezes.

Clip off the scale to cancel Hold mode.

Max/Key: Max. value freezes (at standstill).

Press the ON/OFF key to cancel Hold mode.

Max/Empty: Max. value freezes (at standstill).

Clip off the scale to cancel Hold mode.

Delay/Key: Max. value freezes (movement).

Press the ON/OFF key to cancel Hold mode.

Delay/Empty: Max. value freezes (movement).

Clip off the scale to cancel Hold mode.

■ Print

The 3020 Digital Indicator can be connected to a printer via the serial port to print out scale chits. Up to a max. of 15 print templates can be stored. You can obtain a service software from Soehnle Professional service centres for the 3020/3030 to design print templates with customised contents.

The parameters listed in the standard print templates can be used to design user-defined print templates. In addition, organisation data (identifiers) and user-defined parameters (such as company names) can be included. Please contact your Soehnle Professional service partner about your print template requirements. Start the print routine either by pressing ENTER or by pressing another print command, e.g. the F key.

Configuring the printer port

- **Setting in Setting mode**
(Setting mode > Data Processing > Interface 1 > Application > 2795.11)
- Press ENTER and the F key simultaneously to access Setting mode.
- The arrow points to "Program Settings". Press the TARE key to browse to "Data Processing". Press ENTER.
- The arrow points to "Data transfer". Press the TARE key to browse to "Interface 1". Press ENTER.
- The arrow points to "Application". Press ENTER.
- The arrow points to "2795.11". Press the TARE key or the F key to select the printer to be connected.
- Press ENTER to confirm.

Connection options (factory setting):

none	
2795.11	(Soehnle Professional printer)
2795.12	(Soehnle Professional printer)
Data Processing	(PC)
Barcode	(barcode reader)
Large-format	
display S302	(monitor)

Info about printer

Soehnle Professional printers are stored as standard. However, you can also set up other printers using the 3020/3030 Service Software. Other parameters (baud rate, data bits, parity and XON/XOFF) can be assigned as specified in the printer manual. Please contact service personnel authorised by Soehnle Professional. The parameters set at the factory are configured for Soehnle Professional printers.

Default print templates, factory setting

The print-command keys can be assigned using the print templates in the service software. In the factory setting, the print template below is already stored and assigned. In other words, it can be printed out. This default print template is an example showing what parameters are available.

Date		01.09.08
Time		09:13:28
Scale no.	02	
Gross	W	0.154 kg
Tare	T	0.015 kg

Print-command conditions

The print templates are assigned to print-command conditions using the service software.

The following conditions can be assigned to print templates:

- Print key (ENTER)
- Automatic print/data record once immediately
- Automatic print/data record once after weight change at standstill
- Automatic print/data record after weight change at standstill
- Automatic print/data record after weight change at standstill above the empty message
- Automatic print/data record after weight change at standstill above the empty message if the active empty message was previously active.
- Continuous transmission
- ENTER/Accept key when ORG A is entered
- ENTER/Accept key when ORG B is entered
- ENTER/Accept key when ORG C is entered

- ENTER/Accept key when ORG D is entered
- Key combination INFO, F and ENTER (dependent on settings)
- ENTER/Accept key for manual input
- Print alibi memory

Programming the F key

The F key is programmable to call up various functions. It assumes different functions depending on how it is assigned. The current function is selected in Setting mode.

Access Setting mode by first pressing ENTER and then the F key simultaneously.

In Setting mode you will find the F key programming options under Program Settings > Weighing + Taring > F key.

Select the required function by pressing the F or the TARE key and confirm by pressing ENTER.

The following functions are available:

- Provisional tare
- Dialysis function
- Hold mode
- Second unit
- BMI function

Exit Setting mode by pressing the ORG key.

6 Error messages

■ Error numbers > Cause / Remedy / Info

05 Zeroing not possible

> Deviation from zero point too large

06 Taring no possible

> Empty scale, scale underloaded or overloaded, manual tare input with tare value above max. load

07 Print not permitted

08 No mass unit switchover

09 Print signal buffer full

10 Load cell signal overflow

11 No measuring point signal

12 Check sensor position

> Incorrect lever setting for at least one weighing device or no weigh on at least one weighing device (plausibility check active)

13 Converter failure

15 Measuring point write-protected

16 No measuring point detected

18 Measuring point not zeroed

20 Print format empty

23 Print error

24 Print template memory corrupt

25 No print template(s)

26 Printer update cancelled

30 Alibi memory full

33 Alibi memory contents corrupt

34 Alibi memory empty

35 No or defective alibi memory

36 Cannot write alibi

37 Alibi memory unreadable

40 General data format error

41 Input value too small

42 Input value too big

44 Power-off not allowed

50 Value below zero range limit

> Zeroing not possible because measured value is outside the set zero range limit

51 Value above zero range limit

› Zeroing not possible because measured value is outside the set zero range limit

52 Overload

› Measured value above weighing range

53 Underload

› Measured value below 0 (zero)

55 Place weight on scale

› Scale empty or no clip off setting made according to set clip off factor

75 Replace backup battery

76 Charge batteries

80 Abort external command

81 Timeout external command

82 Number exists already

› The identification assigned to a fixed value exists already

90 Fixed value memory occupied / full

› A total of 100 memory locations are available valid for all programs

98 Wrong barcode

7 Technical information

■ Technical data

Weighing range:	see nameplate
Division:	see nameplate
Min/max load:	see nameplate
Max. bed weight:	250 kg
Approval number:	D07-09-034-PTB (0102)
Ambient operating temperature:	-10°C to +40°C, rapid temperature changes, e.g. in the event of cold draughts, may impair the test result
Storage temperature:	-40°C to +70°C
Humidity:	20%–85% relative humidity, non condensing
Digital indicator power supply:	power adapter/mains voltage 100–240 V / 50–60 Hz
Weighing device power supply:	From 6 V lead-gel battery, battery capacity: 1200 mA continuous duty approx. 12 hours
Transportation conditions:	The appliance may only be transported in its original packaging, comply with storage temperature, avoid vibrations and shocks
Membrane keyboard:	19 keys, function key freely programmable
Organisation data memory:	4 memories, alphanumeric input via the numerical keypad

Display:	Dot matrix 240 x 64 pixels, dimmable, backlighting
Memory capacity:	Fixed value memory for total of 100 fixed values, valid for all programs, power failsafe, alibi memory for 2 million inputs optional
Interfaces:	1 x RS 232, other interfaces optional, Bluetooth Qualification
Materials:	Digital Indicator: housing plastic; weighing devices: aluminium
Wheels	130–160 mm Ø, max. width 71 mm

■ Other technical data

Diagrams, lists of spare parts, and setting instructions can be requested through the manufacturer's Customer Service.

■ Instructions for installing the scale

For design reasons, the scale is designed only for use on level floors. For installation sites in Germany, this condition is met when the floor complies with the tolerance specifications for flat floors to DIN 18202, Table 3, Row 4. For other countries the applicable national standards should be taken as a basis.

■ Electronic nameplate and calibration counter

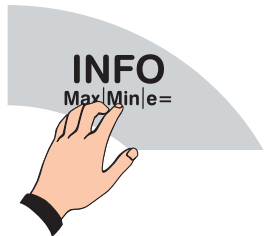

The appliance has an electronic nameplate.

Display by pressing the INFO key. Exit the display by pressing the INFO key again.

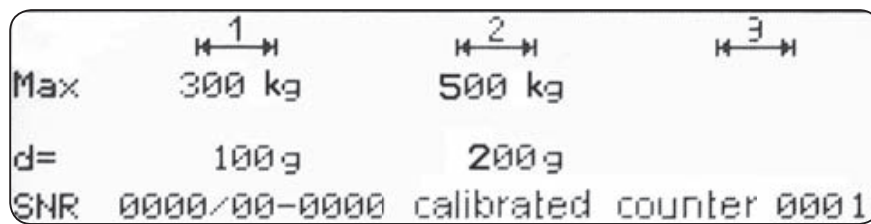

(sample display)

■ Explanations of labels and icons

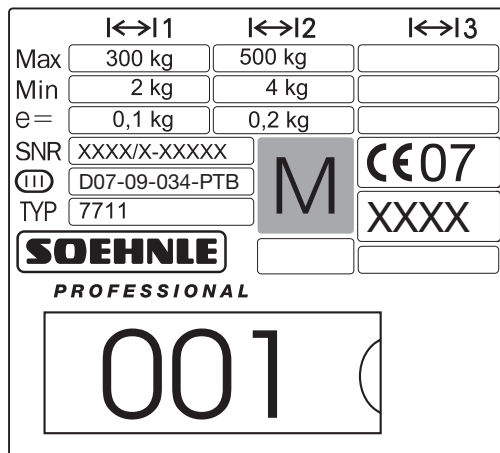

↔1 Weighing ranges

Max Maximum load of weighing range

Min Minimum load of weighing range

e= Calibration value (division)

SNR Scale serial number (scale type, final number of year of manufacture, incremental numeral)

CE07 CE mark of conformity with year of affixing and simultaneous commencement of validity of calibration

(III) Precision class

D07-09-034-PTB No. of EU approval

TYP Manufacturer's product number

XXXX E.g. 0102, Official Code of "Office Quoted" (this body performed the initial calibration process)

ENGLISH

BED SCALE 7711

M

Symbol for EU calibration

001

The calibrated counter status indicates how often the scale was calibrated. The stored counter status must match the calibrated counter status on the inserted label secured by adhesive label.

Load Cell

SN:H2509xx
Typ:SEB46B-300-C3-MR-CC-6L

Soehnle Professional GmbH & Co. KG.

SN Serial number of weighing machine

TYP Product number der Lastaufnehmer

BT Bluetooth Address

IPX2 Protection Class

6V DC Power Supply

80mA Power Input



Attend to user manual, ISO 7010



Equipment for not ionized radiation, IEC 60417



Functional earth, IEC 60417

SOEHNLE
PROFESSIONAL



Typ:7711
SN:771110070001 BT:008025005BBF
IP X2 6V 80 mA
Soehnle Professional GmbH & Co. KG.